

ELEMENTY KOMUNIKACJI PIONOWEJ W BUDYNKACH

SCHODY STAŁE
KLASYFIKACJA SCHODÓW
WEDŁUG RODZAJU
ZASTOSOWANEGO MATERIAŁU

KONSTRUKCJE SCHODÓW MOGĄ BYĆ WYKONANE:

- Z DREWNA
- Z DREWNA I STALI
- Z KAMIENIA
- Z KAMIENIA I STALI
- Z CEGŁY
- Z CEGŁY I STALI
- Z ŻELIWA
- ZE STALI
- Z BETONU
- Z BETONU I STALI
- Z ŻELBETU
- ZE SZKŁA

KONSTRUKCJE DREWNIANE

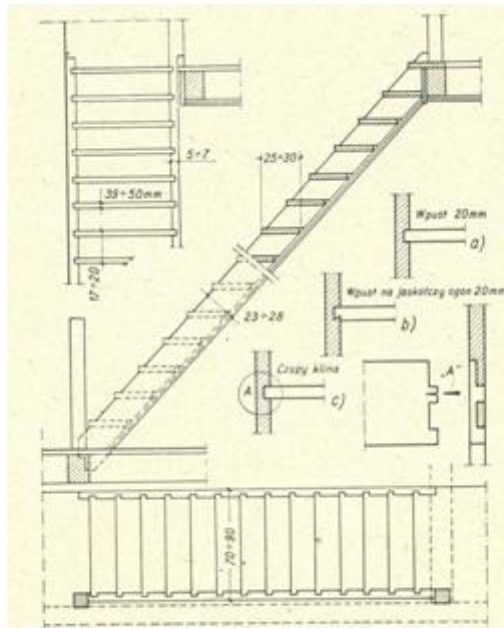

WG. Z. Męczyński Poradnik budowlany dla architektów.

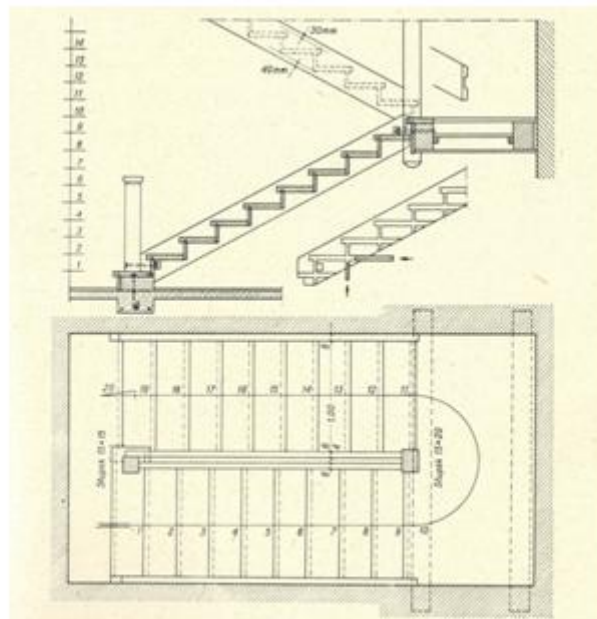

WG. Z. Męczyński Poradnik budowlany dla architektów.

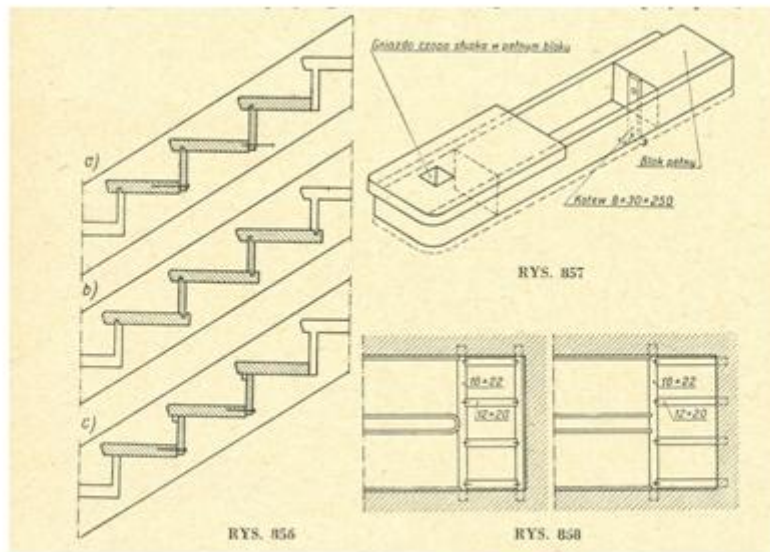

WG. Z. Męczyński Poradnik budowlany dla architektów.

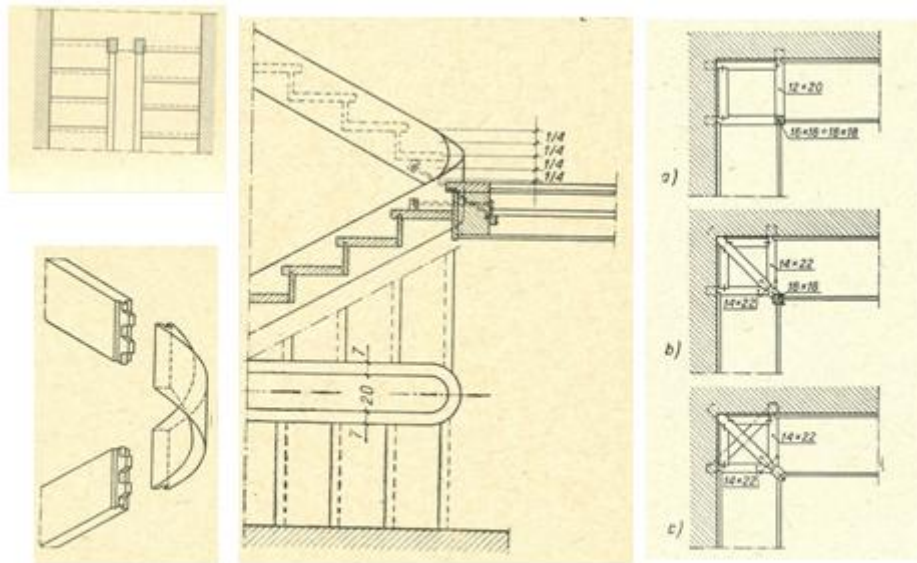

WG. Z. Męczyński Poradnik budowlany dla architektów.

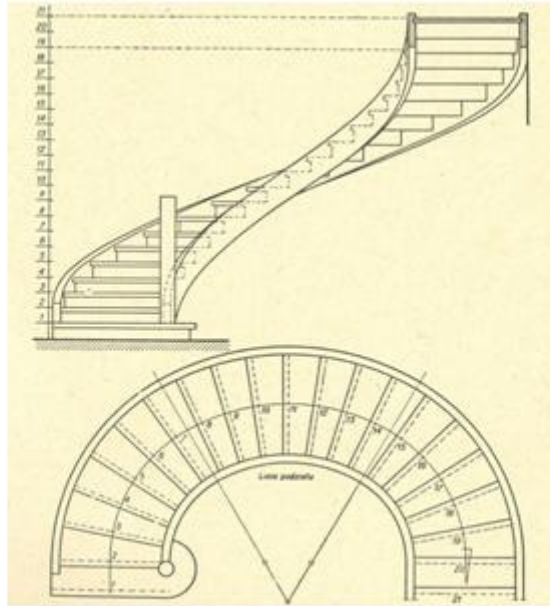

WS. Z. Męczyński Poradnik budowlany dla architektów.

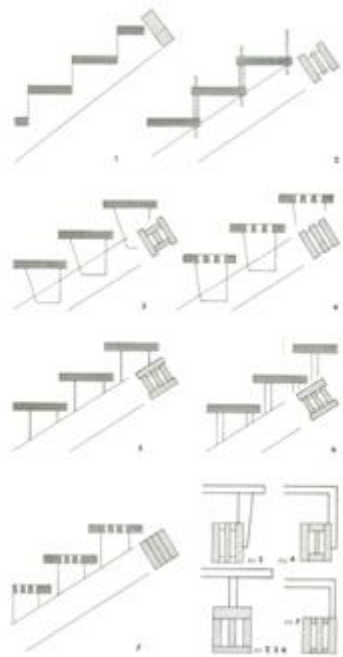
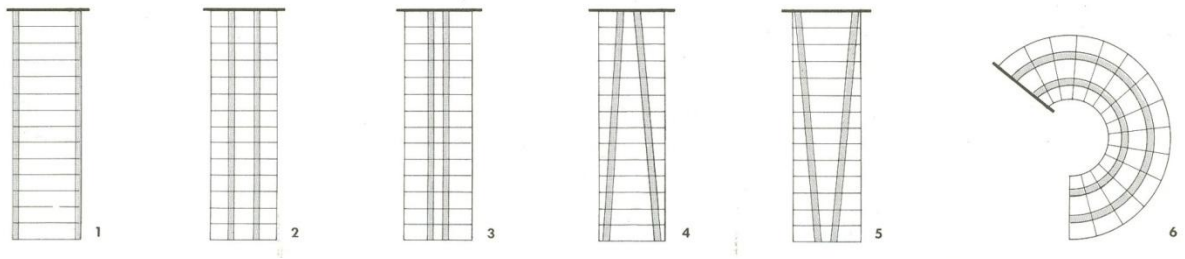

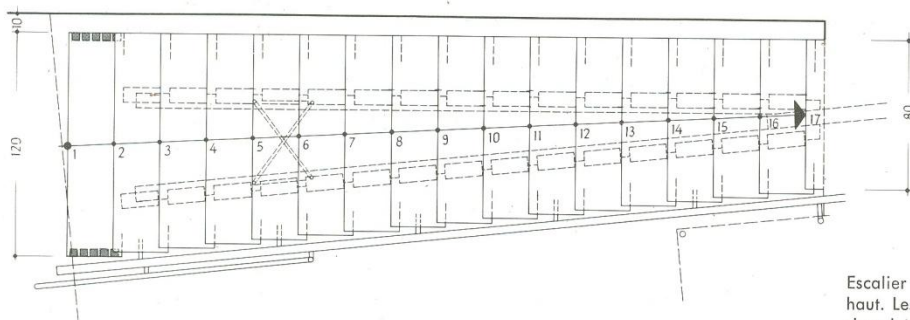
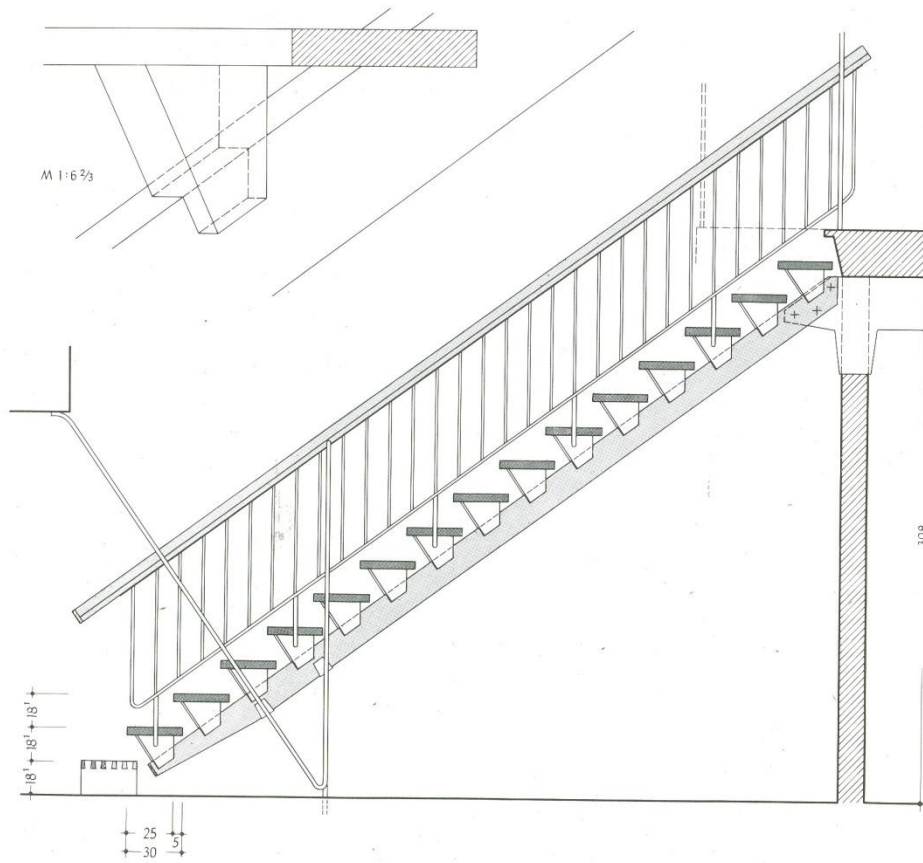

Escalier à l'ha
haut. Les mo
chevalet à tu

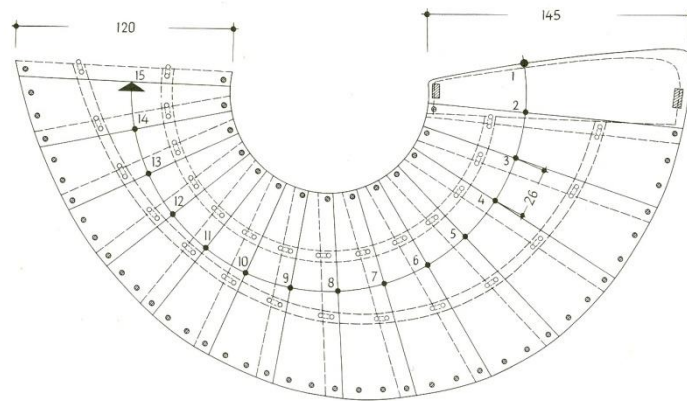
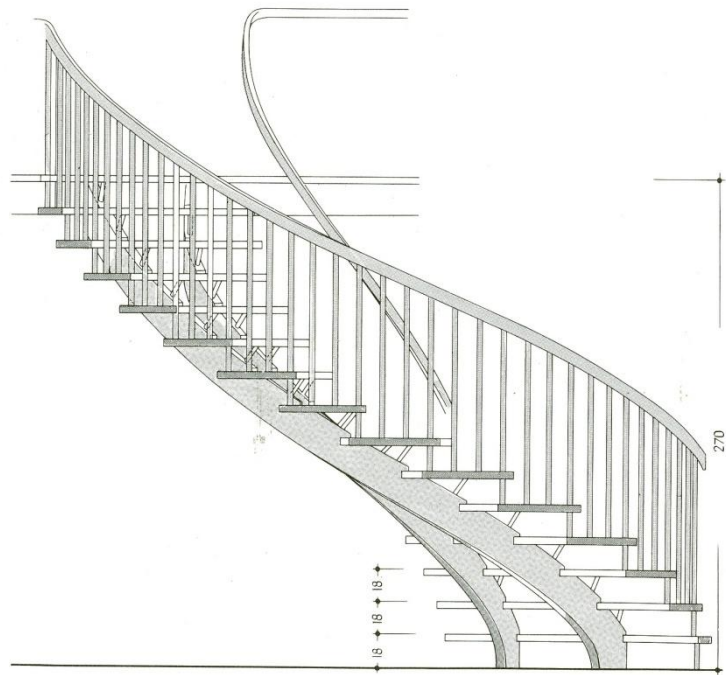

O.Steinhöfel, Holztreppe – Handbuch für Bau von Holztreppe

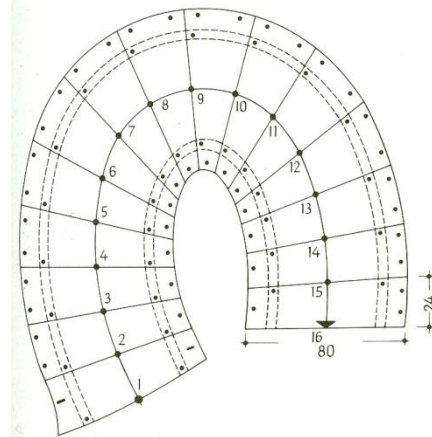
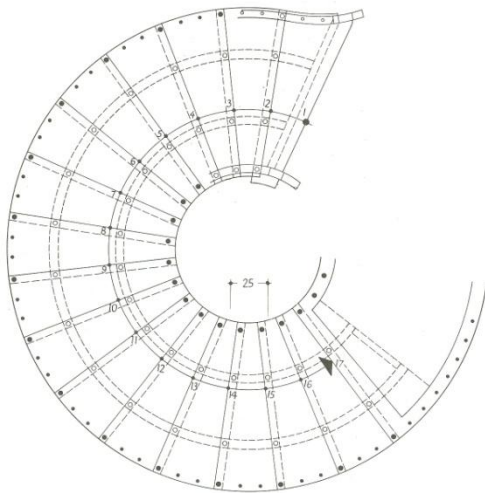
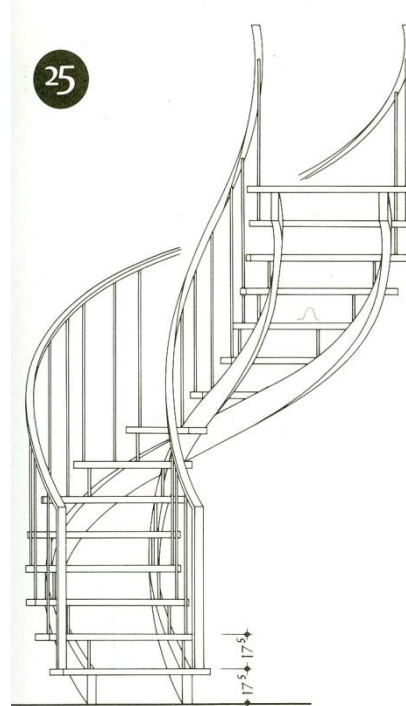

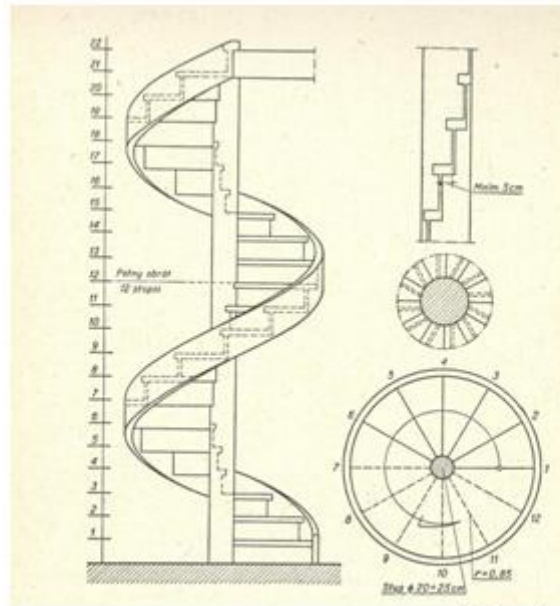

WG. Z. Męczyński Poradnik budowlany dla architektów.

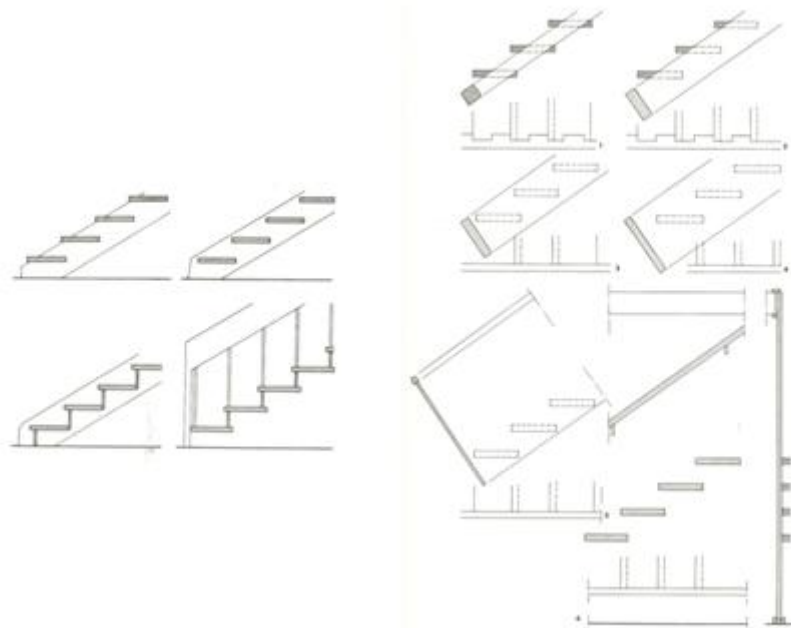

O.Steinhöfel, Holztreppe – Handbuch für Bau von Holztreppe

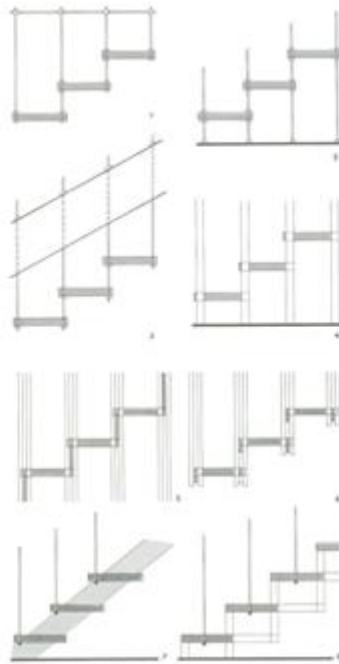
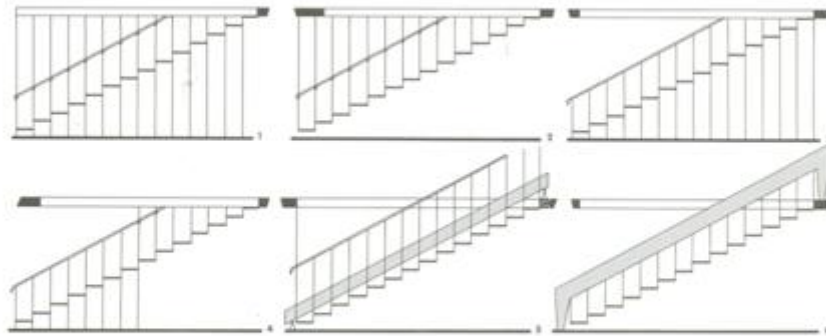

SCHODY KAMIENNE

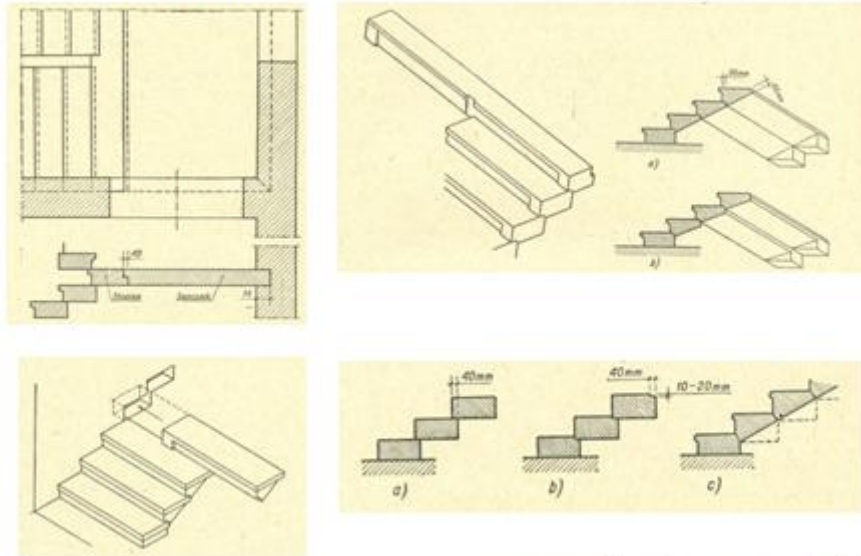

WG. Z. Męczyński Poradnik budowlany dla architektów.

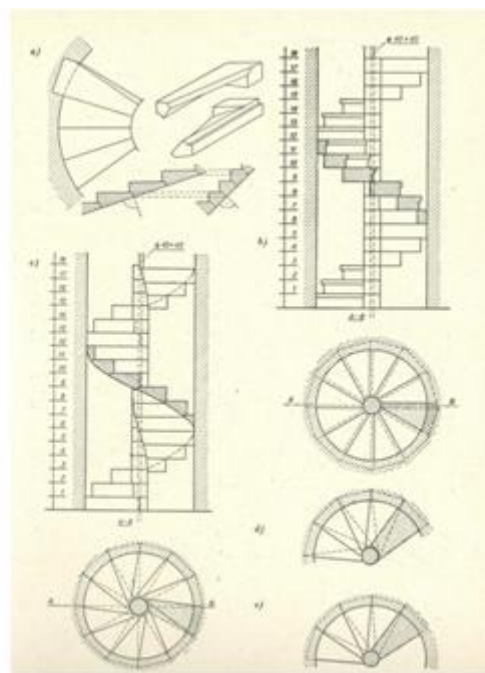

WG. Z. Męczyński Poradnik budowlany dla architektów.

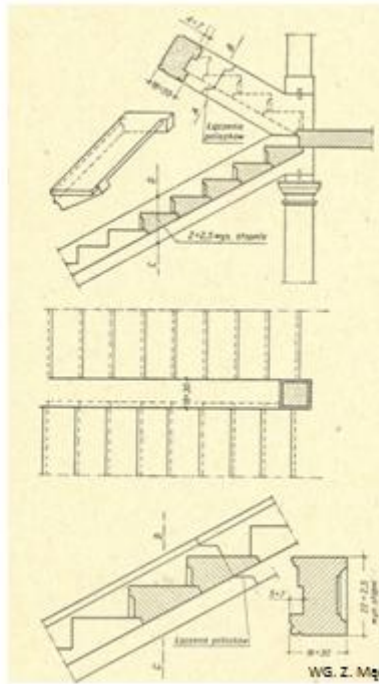

WG. Z. Męczyński Poradnik budowlany dla architektów.

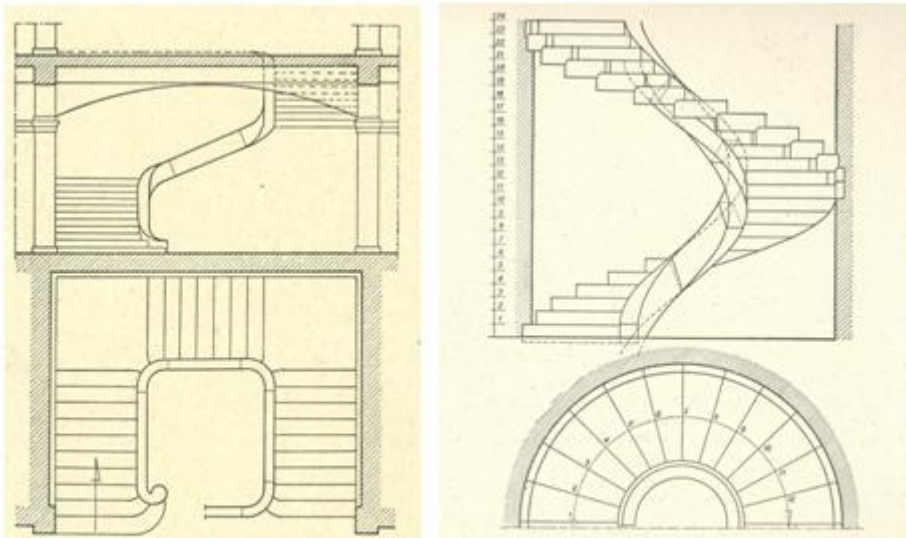

WG. Z. Męczyński Poradnik budowlany dla architektów.

SCHODY STALOWO CERAMICZNE

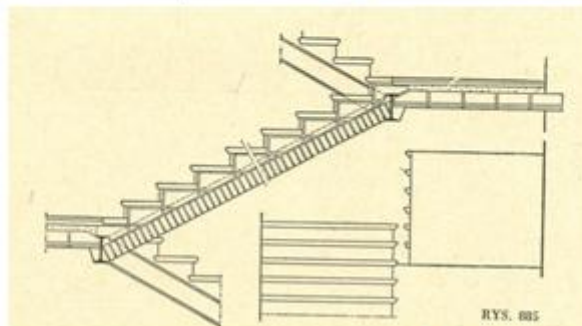
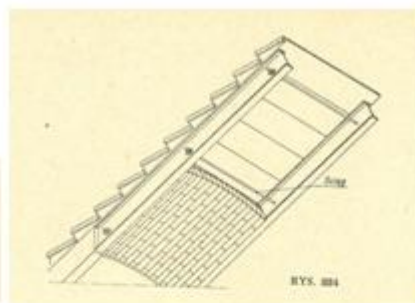
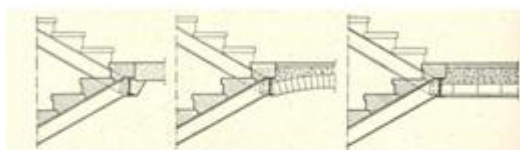

WG. Z. Męczyński Poradnik budowlany dla architektów.

SCHODY ŻELIWNE

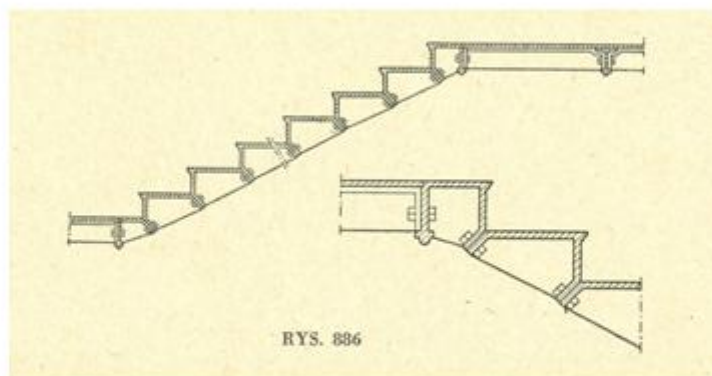

WG. Z. Męczyński Poradnik budowlany dla architektów.

SCHODY STALOWE

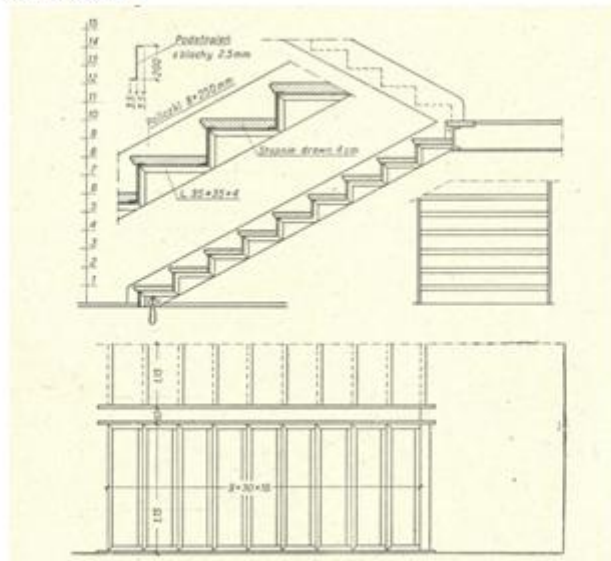

WG. Z. Męczyński Poradnik budowlany dla architektów.

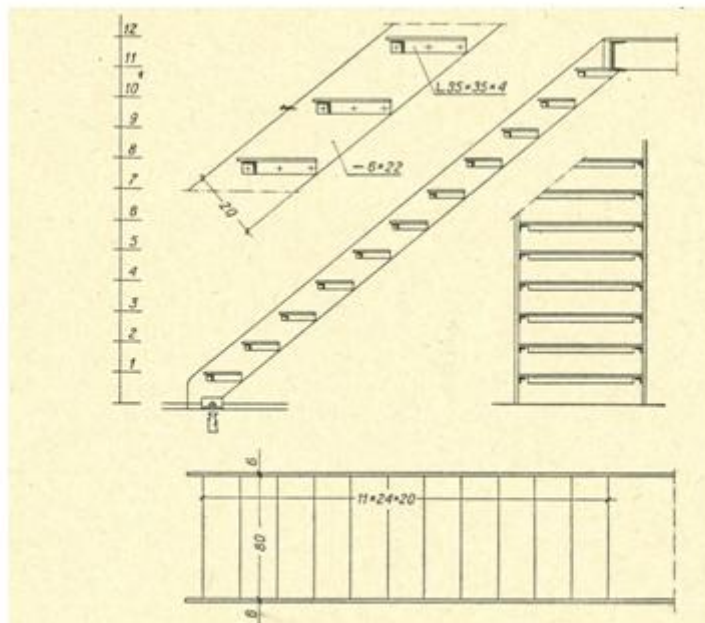

WG. Z. Męczyński Poradnik budowlany dla architektów.

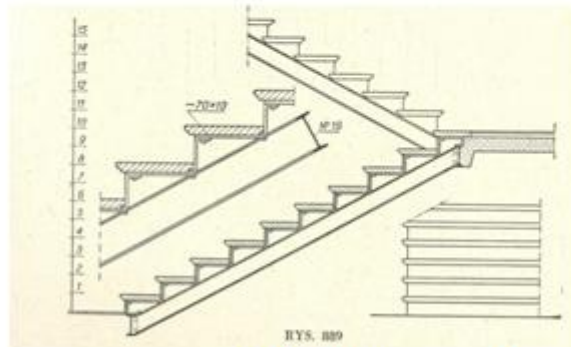
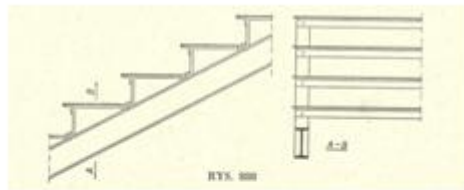

WG. Z. Męczyński Poradnik budowlany dla architektów.

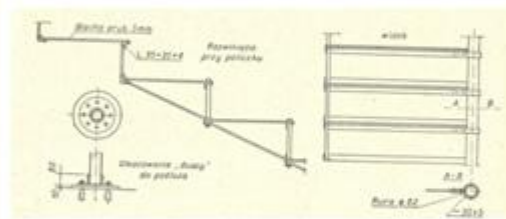
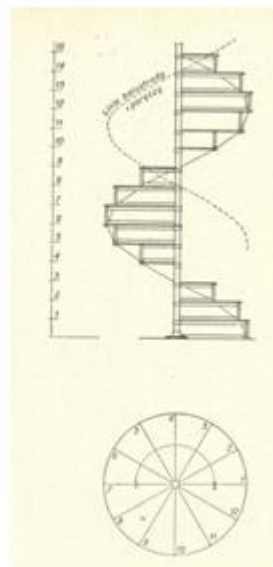

WG. Z. Męczyński Poradnik budowlany dla architektów.

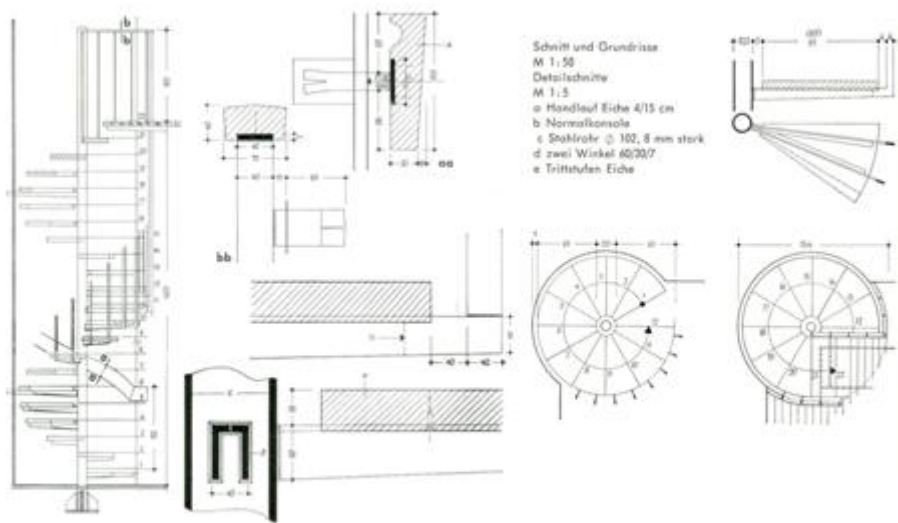

Detail Eingänge Treppen aus Metall

SCHODY ŻELBETOWE PREFABRYKOWANE

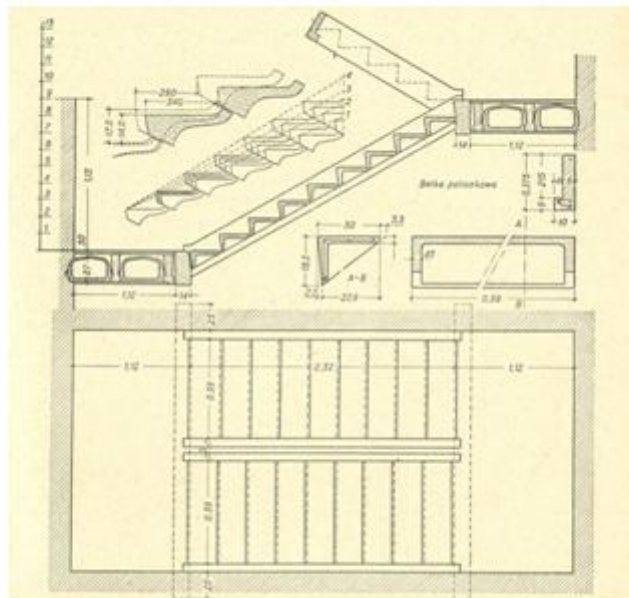

WG. Z. Męczyński Poradnik budowlany dla architektów.

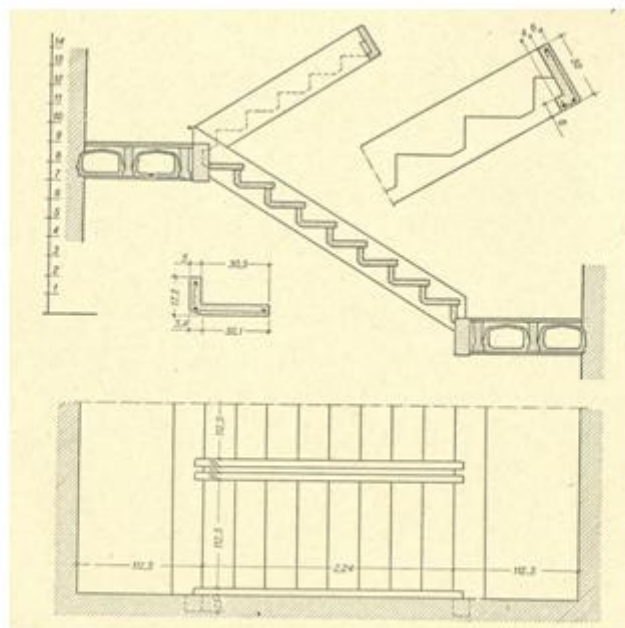

WG. Z. Męczyński Poradnik budowlany dla architektów.

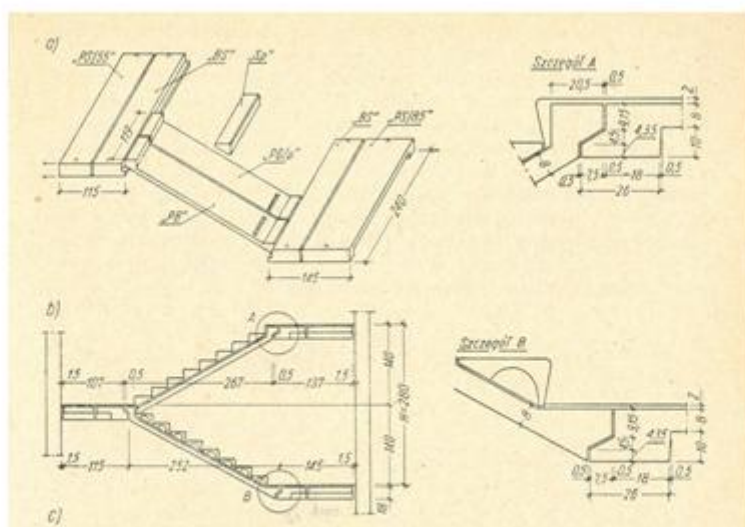

WG. Z. Męczyński Poradnik budowlany dla architektów.

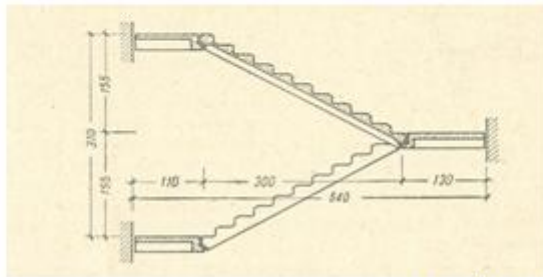
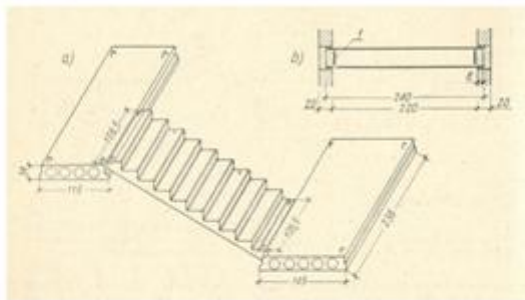

W.G. Z. Męczyński Poradnik budowlany dla architektów.